



SWISS+TOOLS[®]



S w i s s
M I C R O

Schnellwechselsystem
Quick change system
Changement rapide

SCHAUBLIN

Aussenbearbeitung External machining Usinage externe

Vorteile

- Hochgenaue Positionierung des Wechselkopfes
- Passgenaue, steife Schnittstelle mit Kegel/Plananlage
- hohe Wiederholgenauigkeit
- Spitzenhöhe ist gewährleistet
- Innenkühlung ist Standard
- Ausserhalb der Maschine voreinstellbar
- Einfaches Handling (nur eine Klemmschraube)

Advantages

- Highly accurate positioning of the replaceable head
- Precisely fitting, rigid interface with cone/face contact
- high repeatability
- Center height is guaranteed
- Internal cooling is standard
- Presettable outside the machine
- Easy handling (only one clamping screw)

Advantages

- Positionnement extrêmement précis de la tête interchangeable
- Interface rigide et parfaitement ajustée avec cône/système plat
- répétabilité élevée
- La hauteur de centre est garantie
- Le refroidissement interne est standard
- Pré-réglable en dehors de la machine
- Manipulation facile (une seule vis de serrage)

10 x 10 mm
12 x 12 mm
16 x 16 mm
20 x 20 mm
1/2" x 1/2"
5/8" x 5/8"

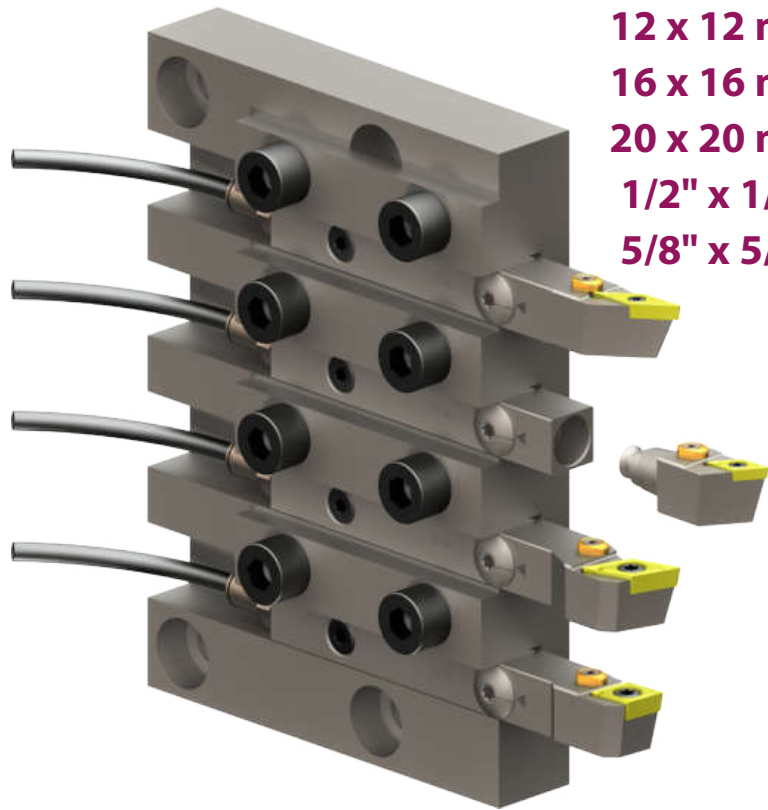

Schnellwechselsystem: Der Vierkantschaft kann in der Maschine gespannt bleiben. Es wird nur das Bearbeitungswerkzeug / Wechselkopf ersetzt. Eine **Voreinstellung** ist ausserhalb der Maschine möglich.

Quick change, without having to remove the tool-holder from the gang. **Presetting** is possible outside of the machine.

Changement rapide sans avoir besoin de sortir le porte-outil du peigne. **Préréglage** possible en dehors de la machine.



Hochdruckkühlung Innenkühlung
High pressure inner coolant
Porte-outils avec arrosage par le centre

Innenbearbeitung

Internal machining

Usinage interne

Vorteile

- Hochgenaue Positionierung des Wechselkopfes
- Passgenaue, steife Schnittstelle mit Kegel/Plananlage
- hohe Wiederholgenauigkeit
- Spitzenhöhe ist gewährleistet
- Innenkühlung ist Standard
- Ausserhalb der Maschine voreinstellbar
- Einfaches Handling (nur eine Klemmschraube)

Advantages

- Highly accurate positioning of the replaceable head
- Precisely fitting, rigid interface with cone/face contact
- high repeatability
- Center height is guaranteed
- Internal cooling is standard
- Presettable outside the machine
- Easy handling (only one clamping screw)

Advantages

- Positionnement extrêmement précis de la tête interchangeable
- Interface rigide et parfaitement ajustée avec cône/système plat
- répétabilité élevée
- La hauteur de centre est garantie
- Le refroidissement interne est standard
- Pré-réglable en dehors de la machine
- Manipulation facile (une seule vis de serrage)



Schnellwechselsystem: Der Rundschaft kann in der Maschine gespannt bleiben. Es wird nur das Bearbeitungswerkzeug / Wechselkopf ersetzt. Eine **Voreinstellung** ist ausserhalb der Maschine möglich.

Quick change, without having to remove the tool-holder from the gang. **Presetting** is possible outside of the machine.

Changement rapide sans avoir besoin de sortir le porte-outil du peigne. **Pré-réglage** possible en dehors de la machine.

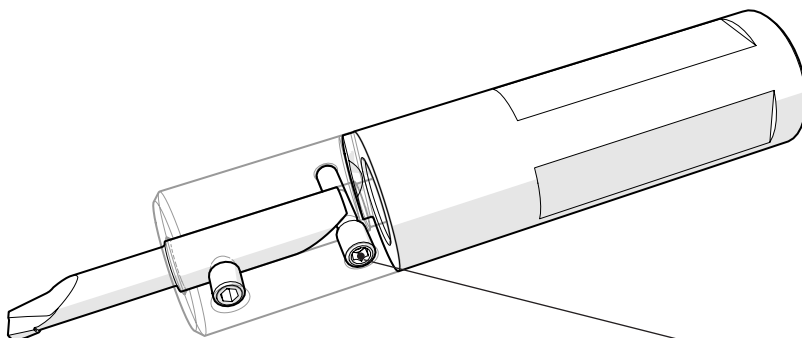

Schneideinsatz wird durch den Stift auf **Spitzenhöhe** ausgerichtet

The pin is guaranteed the correct position of the cutting edge **high**.

La goupille place le tranchant au **centre haut**.



Grundhalter vierkant

Square holders

Supports carrés

	1	2	3	4
V12.LW3.K01.080	V12	LW3	K01	080

1	Schaftgrösse Shank size Dimensions de burin	V10 V12 V13 V15 V16 V20	10 x 10 mm 12 x 12 mm 1/2 x 1/2 " 5/8 x 5/8 " 16 x 16 mm 20 x 20 mm
2	Schnittstelle Interface Interface	LW2 LW3 LW4 LW5	10 x 10 mm 12 x 12 mm 1/2 x 1/2 " 16 x 16 mm 5/8 x 5/8 " 20 x 20 mm
3	Kühlmittel Coolant Arrosage	K01	Innere Kühlmittelduchführung Inner coolant supply Avec arrosage interne
4	Schaftlänge Shank length Longueur de tige	080	80 mm



Wechselschneidköpfe





Interchangeable heads

Têtes interchangeable

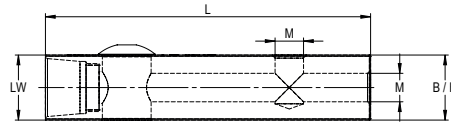
	1	2	3	4
LW3.SCLCR.0620.09	LW3	SCLCR	0620	09

1	Schnittstelle Interface Interface	LW2 LW3 LW4 LW5	10 x 10 mm 12 x 12 mm 1/2 x 1/2 " 16 x 16 mm 5/8 x 5/8 " 20 x 20 mm
2	ISO Bezeichnung ISO Code ISO Code	SCLCR	WP-Typ, Spannung, Einbaulage Insert typ, clamping, orientation
3	Abmessung Dimension Dimension	06 20	f - Mass / Länge L - dimension / length
4	Schneidenlänge Cutting length longueur de coupe	09	Wendeplattengösse Insert size Plaquette taille







Bestell-Nr. / Order number/ Code	SG	b/h	L	LW	Coolant M	kg				
V10.LW2.K01.080	10	10 / 10	80	2	M8x1	0.06	LWX.ER1.008.004	LW2-ER1.010.012 (3.0 Nm)	J00.895.000.030	J00.895.002.015 (TX15)
V12.LW3.K01.080	12	12 / 12	80	3	M8x1	0.06	LWX.ER1.008.004	LW3-ER1.012.014 (3.8 Nm)	J00.895.000.038	J00.895.002.015 (TX15)
V13.LW3.K01.080	1/2"	12 / 12.7	80	3	M8x1	0.07	LWX.ER1.008.004	LW3-ER1.012.014 (3.8 Nm)	J00.895.000.038	J00.895.002.015 (TX15)
V15.LW4.K01.080	5/8"	16 / 15.875	80	4	M8x1	0.12	LWX.ER1.008.004	LW4-ER1.014.019 (5.7 Nm)	J00.895.000.057	J00.895.002.020 (TX20)
V16.LW4.K01.080	16	16 / 16	80	4	M8x1	0.13	LWX.ER1.008.004	LW4-ER1.014.019 (5.7 Nm)	J00.895.000.057	J00.895.002.020 (TX20)
V20.LW5.K01.100	20	20 / 20	100	5	M8x1	0.27	LWX.ER1.008.004	LW5-ER1.015.023 (5.7 Nm)	J00.895.000.057	J00.895.002.020 (TX20)

- für effiziente Drehbearbeitung
- mit Kühlmitteldirektanschluss
- Sonderabmasse auf Anfrage
- Benutzung eines Drehmomentschlüssel empfohlen

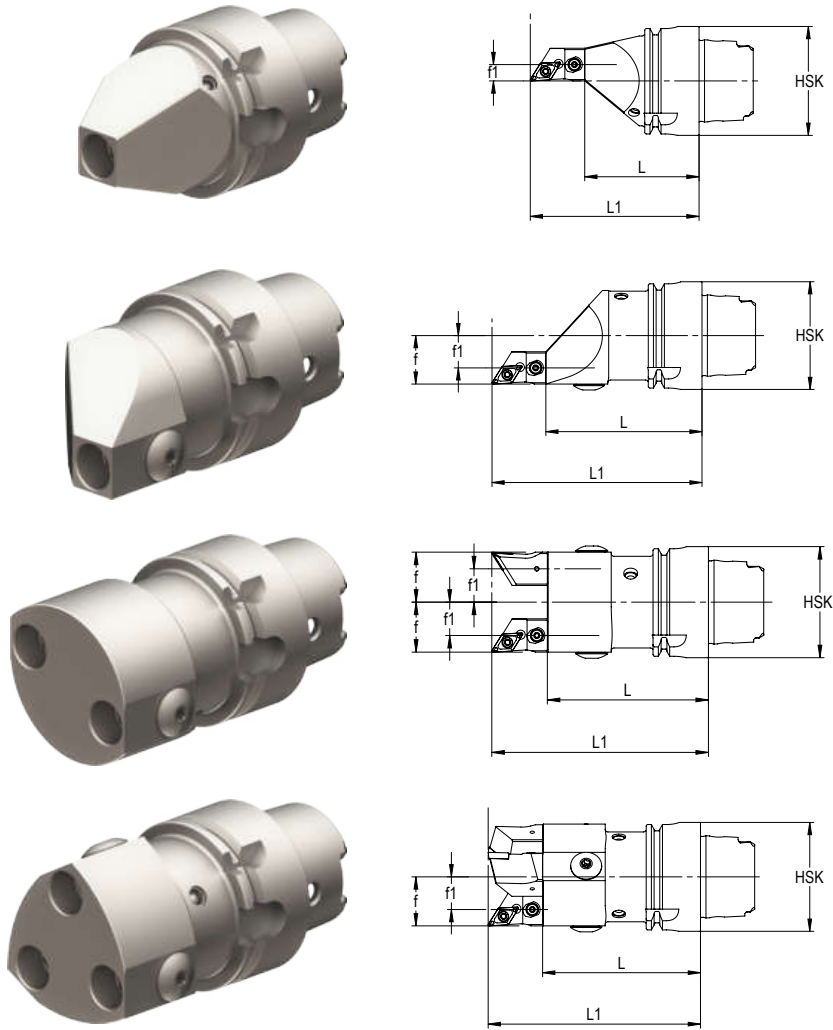
- to turn efficiently
- with direct coolant connection
- Special dimensions on request
- Recommended use of dynamometric key

- pour un tournage efficace
- avec raccord direct de liquide de refroidissement
- Dimensions spéciales sur demande
- Utilisation clé dynamométrique recommandée







Bestell.Nr. / Order number/ Code	LW	HSK	f1	f	L	kg			
HA4.LW3.RF0.042	3	T40	6	0	42	0.29	LW3.ER1.012.014 (3.8 Nm)	J00.895.000.038	J00.895.002.015 (TX15)
HA4.LW3.R11.058	3	T40	12	18	58	0.38	LW3.ER1.012.014 (3.8 Nm)	J00.895.000.038	J00.895.002.015 (TX15)
HA4.LW3.R21.058	3	T40	12	18	58	0.45	LW3.ER1.012.014 (3.8 Nm)	J00.895.000.038	J00.895.002.015 (TX15)
HA4.LW3.R31.058	3	T40	12	18	58	0.44	LW3.ER1.012.014 (3.8 Nm)	J00.895.000.038	J00.895.002.015 (TX15)
HA4.LW3.RF0.042-Bum*	3	A40	6	0	42	0.29	LW3.ER1.012.014 (3.8 Nm)	J00.895.000.038	J00.895.002.015 (TX15)
HA4.LW3.R11.058-Bum*	3	A40	12	18	58	0.38	LW3.ER1.012.014 (3.8 Nm)	J00.895.000.038	J00.895.002.015 (TX15)
HA4.LW3.R21.058-Bum*	3	A40	12	18	58	0.45	LW3.ER1.012.014 (3.8 Nm)	J00.895.000.038	J00.895.002.015 (TX15)
HA4.LW3.R31.058-Bum*	3	A40	12	18	58	0.44	LW3.ER1.012.014 (3.8 Nm)	J00.895.000.038	J00.895.002.015 (TX15)

- für effiziente Drehbearbeitung
- mit Innenkühlung
- Benutzung eines Drehmomentschlüssel empfohlen
- *Bum = BUMOTEC HSK A Spindel

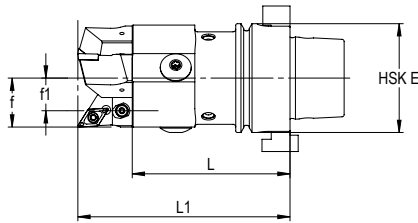
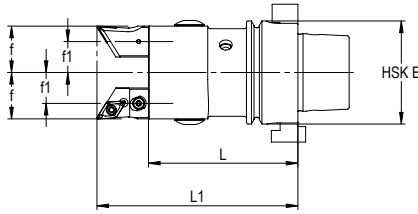
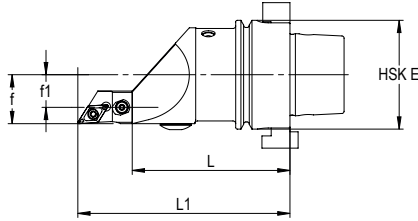
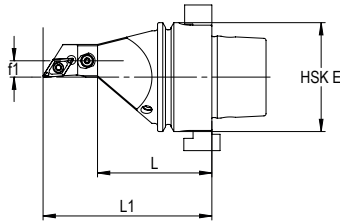
- to turn efficiently
- with inner coolant supply
- Recommended use of dynamometric key
- *Bum = BUMOTEC HSK A spindle

- pour un tournage efficace
- avec arrosage interne
- Utilisation clé dynamométrique recommandée
- *Bum = BUMOTEC HSK A broche







Bestell.Nr. / Order number/ Code	LW	HSK	f1	f	L	kg			
HW4.LW3.RF0.042	3	E40*	6	0	42	0.29	LW3.ER1.012.014 (3.8 Nm)	J00.895.000.038	J00.895.002.015 (TX15)
HW4.LW3.R11.058	3	E40*	12	18	58	0.38	LW3.ER1.012.014 (3.8 Nm)	J00.895.000.038	J00.895.002.015 (TX15)
HW4.LW3.R21.058	3	E40*	12	18	58	0.45	LW3.ER1.012.014 (3.8 Nm)	J00.895.000.038	J00.895.002.015 (TX15)
HW4.LW3.R31.058	3	E40*	12	18	58	0.44	LW3.ER1.012.014 (3.8 Nm)	J00.895.000.038	J00.895.002.015 (TX15)

- für effiziente Drehbearbeitung
- mit Innenkühlung
- Benutzung eines Drehmomentschlüssel empfohlen
- *E40 = WILLEMIN MACODEL

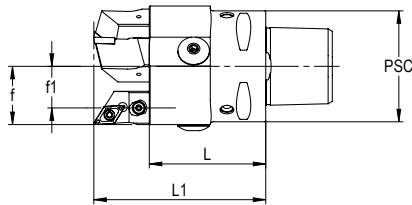
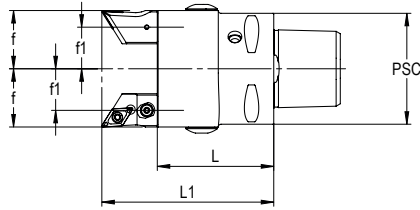
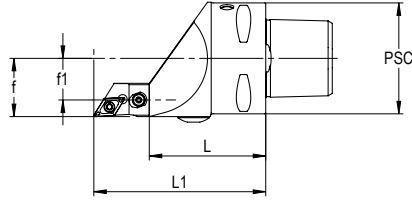
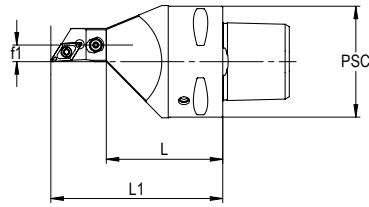
- to turn efficiently
- with inner coolant supply
- Recommended use of dynamometric key
- *E40 = WILLEMIN MACODEL

- pour un tournage efficace
- avec arrosage interne
- Utilisation clé dynamométrique recommandée
- *E40 = WILLEMIN MACODEL



Bestell.Nr. / Order number/ Code	LW	PSC	f1	f	L	kg			
PS4.LW3.RF0.042	3	40	6	0	42	0.38	LW3.ER1.012.014 (3.8 Nm)	J00.895.000.038	J00.895.002.015 (TX15)
PS4.LW3.R11.042	3	40	15	21	42	0.36	LW3.ER1.012.014 (3.8 Nm)	J00.895.000.038	J00.895.002.015 (TX15)
PS4.LW3.R21.042	3	40	15	21	42	0.45	LW3.ER1.012.014 (3.8 Nm)	J00.895.000.038	J00.895.002.015 (TX15)
PS4.LW3.R31.042	3	40	15	21	42	0.46	LW3.ER1.012.014 (3.8 Nm)	J00.895.000.038	J00.895.002.015 (TX15)

- für effiziente Drehbearbeitung
- mit Innenkühlung
- Benutzung eines Drehmomentschlüssel empfohlen

- to turn efficiently
- with inner coolant supply
- Recommended use of dynamometric key

- pour un tournage efficace
- avec arrosage interne
- Utilisation clé dynamométrique recommandée

SCLC R/L 95°/80°

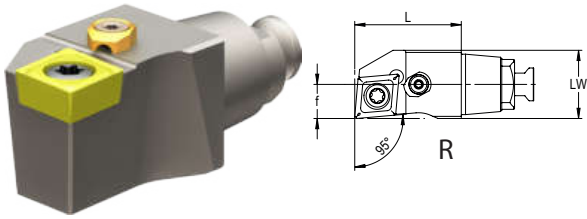

Bestell.Nr. / Order number/ Code	LW	f	L	Wendeplatte/ Insert/ Plaquette	kg				
LW2.SCLC(R/L).0520.06	2	5	20	ISO - CC . . 06 02 . . ANSI - CC . . 21.5 . .	0.02	WCA.ER1.001.000	WCA.ER2.001.006 (0.9 Nm)	LWX.ER1.007.002	LW2.U00.ER1.000
LW3.SCLC(R/L).0620.06	3	6	20	ISO - CC . . 06 02 . . ANSI - CC . . 21.5 . .	0.03	WCA.ER1.001.000	WCA.ER2.001.006 (0.9 Nm)	LWX.ER1.007.002	LW3.U00.ER1.000
LW3.SCLC(R/L).0620.09	3	6	20	ISO - CC . . 09 T3 . . ANSI - CC . . 32.5 . .	0.03	WCB.ER1.001.000	WCB.ER2.001.009 (3.0 Nm)	LWX.ER1.007.002	LW3.U00.ER1.000
LW4.SCLC(R/L).0825.06	4	8	25	ISO - CC . . 09 T3 . . ANSI - CC . . 32.5 . .	0.04	WCA.ER1.001.000	WCA.ER2.001.006 (0.9 Nm)	LWX.ER1.007.002	LW4.U00.ER1.000
LW4.SCLC(R/L).0825.09	4	8	25	ISO - CC . . 09 T3 . . ANSI - CC . . 32.5 . .	0.04	WCB.ER1.001.000	WCB.ER2.001.009 (3.0 Nm)	LWX.ER1.007.002	LW4.U00.ER1.000
LW5.SCLC(R/L).1025.09	5	10	25	ISO - CC . . 09 T3 . . ANSI - CC . . 32.5 . .	0.07	WCB.ER1.001.000	WCB.ER2.001.009 (3.0 Nm)	LWX.ER1.007.002	LW4.U00.ER1.000

SCMC N 50°/80°/50°

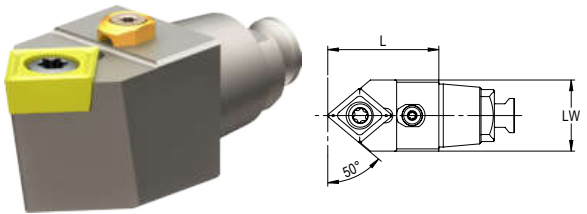

Bestell.Nr. / Order number/ Code	LW	f	L	Wendeplatte/ Insert/ Plaquette	kg				
LW2.SCMCN.0020.06	2	0	20	ISO - CC . . 06 02 . . ANSI - CC . . 21.5 . .	0.02	WCA.ER1.001.000	WCA.ER2.001.006 (0.9 Nm)	LWX.ER1.007.002	LW2.U00.ER1.000
LW3.SCMCN.0020.06	3	0	20	ISO - CC . . 06 02 . . ANSI - CC . . 21.5 . .	0.03	WCA.ER1.001.000	WCA.ER2.001.006 (0.9 Nm)	LWX.ER1.007.002	LW3.U00.ER1.000
LW3.SCMCN.0020.09	3	0	20	ISO - CC . . 09 T3 . . ANSI - CC . . 32.5 . .	0.03	WCB.ER1.001.000	WCB.ER2.001.009 (3.0 Nm)	LWX.ER1.007.002	LW3.U00.ER1.000
LW4.SCMCN.0025.06	4	0	25	ISO - CC . . 06 02 . . ANSI - CC . . 21.5 . .	0.04	WCA.ER1.001.000	WCA.ER2.001.006 (0.9 Nm)	LWX.ER1.007.002	LW4.U00.ER1.000
LW4.SCMCN.0025.09	4	0	25	ISO - CC . . 09 T3 . . ANSI - CC . . 32.5 . .	0.04	WCB.ER1.001.000	WCB.ER2.001.009 (3.0 Nm)	LWX.ER1.007.002	LW4.U00.ER1.000
LW5.SCMCN.0025.09	5	0	25	ISO - CC . . 09 T3 . . ANSI - CC . . 32.5 . .	0.06	WCB.ER1.001.000	WCB.ER2.001.009 (3.0 Nm)	LWX.ER1.007.002	LW4.U00.ER1.000

PCLN R/L 95°/80°

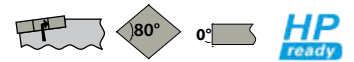
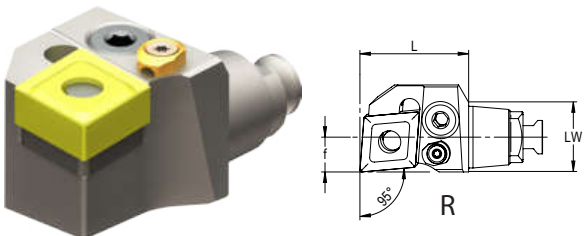

Bestell.Nr. / Order number/ Code	LW	f	L	Wendeplatte/ Insert/ Plaquette	kg					
LW4.PCLN(R/L).0825.12	4	8	25	ISO - CN . . 12 04 . . ANSI - CN . . 43 . .	0.04	WCD.ER2.101.003	WCD.ER4.101.017 (5.0 Nm)	WCD.ER3.101.000	WCD.ER1.101.000	LWX.ER1.007.002
LW5.PCLN (R/L).1030.12	5	10	30	ISO - CN . . 12 04 . . ANSI - CN . . 43 . .	0.1	WCD.ER2.101.003	WCD.ER4.101.017 (5.0 Nm)	WCD.ER3.101.000	WCD.ER1.101.000	LWX.ER1.007.002

SDNC N 50°/80°/50°

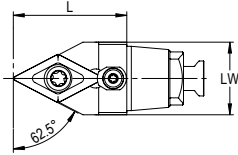
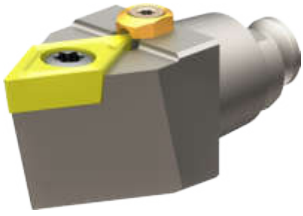

Bestell.Nr. / Order number/ Code	LW	f	L	Wendeplatte/ Insert/ Plaquette	kg				
LW2.SDNCN.0020.07	2	0	20	ISO - DC .. 07 02 .. ANSI - DC .. 21.5 ..	0.02	WCA.ER1.001.000	WCA.ER2.001.006 (0.9 Nm)	LWX.ER1.007.002	LW2.U00.ER1.000
LW3.SDNCN.0020.07	3	0	20	ISO - DC .. 07 02 .. ANSI - DC .. 21.5 ..	0.03	WCA.ER1.001.000	WCA.ER2.001.006 (0.9 Nm)	LWX.ER1.007.002	LW3.U00.ER1.000
LW3.SDNCN.0025.11	3	0	25	ISO - DC .. 11 T3 .. ANSI - DC .. 32.5 ..	0.03	WCB.ER1.001.000	WCB.ER2.001.009 (3.0 Nm)	LWX.ER1.007.002	LW3.U00.ER1.000
LW4.SDNCN.0025.07	4	0	25	ISO - DC .. 07 02 .. ANSI - DC .. 21.5 ..	0.04	WCA.ER1.001.000	WCA.ER2.001.006 (0.9 Nm)	LWX.ER1.007.002	LW4.U00.ER1.000
LW4.SDNCN.0025.11	4	0	25	ISO - DC .. 11 T3 .. ANSI - DC .. 32.5 ..	0.04	WCB.ER1.001.000	WCB.ER2.001.009 (3.0 Nm)	LWX.ER1.007.002	LW4.U00.ER1.000
LW5.SDNCN.0030.07	5	0	30	ISO - DC .. 07 02 .. ANSI - DC .. 21.5 ..	0.07	WCA.ER1.001.000	WCA.ER2.001.006 (0.9 Nm)	LWX.ER1.007.002	LW4.U00.ER1.000
LW5.SDNCN.0030.11	5	0	30	ISO - DC .. 11 T3 .. ANSI - DC .. 32.5 ..	0.07	WCB.ER1.001.000	WCB.ER2.001.009 (3.0 Nm)	LWX.ER1.007.002	LW4.U00.ER1.000

SDJC R/L 93°/55°

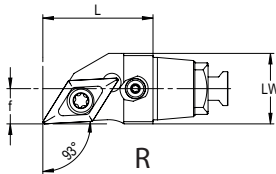

Bestell.Nr. / Order number/ Code	LW	f	L	Wendeplatte/ Insert/ Plaquette	kg				
LW2.SDJC(R/L).0520.07	2	5	20	ISO - DC .. 07 02 .. ANSI - DC .. 21.5 ..	0.02	WCA.ER1.001.000	WCA.ER2.001.006 (0.9 Nm)	LWX.ER1.007.002	LW2.U00.ER1.000
LW3.SDJC(R/L).0620.07	3	6	20	ISO - DC .. 07 02 .. ANSI - DC .. 21.5 ..	0.03	WCA.ER1.001.000	WCA.ER2.001.006 (0.9 Nm)	LWX.ER1.007.002	LW3.U00.ER1.000
LW3.SDJC(R/L).0625.11	3	6	25	ISO - DC .. 11 T3 .. ANSI - DC .. 32.5 ..	0.03	WCB.ER1.001.000	WCB.ER2.001.009 (3.0 Nm)	LWX.ER1.007.002	LW3.U00.ER1.000
LW4.SDJC(R/L).0825.07	4	8	25	ISO - DC .. 07 02 .. ANSI - DC .. 21.5 ..	0.04	WCA.ER1.001.000	WCA.ER2.001.006 (0.9 Nm)	LWX.ER1.007.002	LW4.U00.ER1.000
LW4.SDJC(R/L).0825.11	4	8	25	ISO - DC .. 11 T3 .. ANSI - DC .. 32.5 ..	0.04	WCB.ER1.001.000	WCB.ER2.001.009 (3.0 Nm)	LWX.ER1.007.002	LW4.U00.ER1.000
LW5.SDJC(R/L).1025.11	5	10	25	ISO - DC .. 11 T3 .. ANSI - DC .. 32.5 ..	0.06	WCB.ER1.001.000	WCB.ER2.001.009 (3.0 Nm)	LWX.ER1.007.002	LW4.U00.ER1.000

SDHC R/L 107.5°/55°

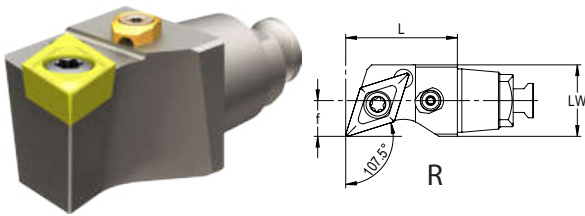

Bestell.Nr. / Order number/ Code	LW	f	L	Wendeplatte/ Insert/ Plaquette	kg				
LW2.SDHC(R/L).0520.07	2	5	20	ISO - DC . . 07 02 . . ANSI - DC . . 21.5 . .	0.02	WCA.ER1.001.000	WCA.ER2.001.006 (0.9 Nm)	LWX.ER1.007.002	LW2.U00.ER1.000
LW3.SDHC(R/L).0620.07	3	6	20	ISO - DC . . 07 02 . . ANSI - DC . . 21.5 . .	0.03	WCA.ER1.001.000	WCA.ER2.001.006 (0.9 Nm)	LWX.ER1.007.002	LW3.U00.ER1.000
LW3.SDHC(R/L).0625.11	3	6	25	ISO - DC . . 11 T3 . . ANSI - DC . . 32.5 . .	0.03	WCB.ER1.001.000	WCB.ER2.001.009 (3.0 Nm)	LWX.ER1.007.002	LW3.U00.ER1.000
LW4.SDHC(R/L).0825.07	4	8	25	ISO - DC . . 07 02 . . ANSI - DC . . 21.5 . .	0.04	WCA.ER1.001.000	WCA.ER2.001.006 (0.9 Nm)	LWX.ER1.007.002	LW4.U00.ER1.000
LW4.SDHC(R/L).0825.11	4	8	25	ISO - DC . . 11 T3 . . ANSI - DC . . 32.5 . .	0.04	WCB.ER1.001.000	WCB.ER2.001.009 (3.0 Nm)	LWX.ER1.007.002	LW4.U00.ER1.000
LW5.SDHC(R/L).1025.11	5	10	25	ISO - DC . . 11 T3 . . ANSI - DC . . 32.5 . .	0.07	WCB.ER1.001.000	WCB.ER2.001.009 (3.0 Nm)	LWX.ER1.007.002	LW4.U00.ER1.000

PDJN R/L 93°/55°

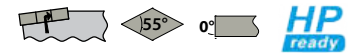
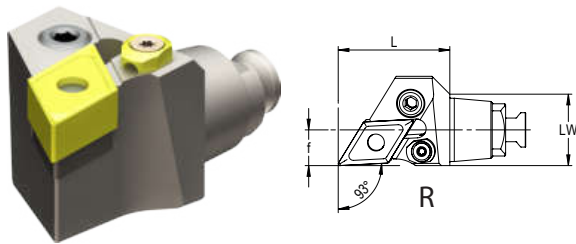

Bestell.Nr. / Order number/ Code	LW	f	L	Wendeplatte/ Insert/ Plaquette	kg					
LW4.PDJN(R/L).0825.11	4	8	25	ISO - DN . . 11 04 . . ANSI - DN . . 33 . .	0.04	WDE.ER2.101.003	WDE.ER4.101.017	WDE.ER3.101.000	WDE.ER1.101.000	LWX.ER1.007.002
LW5.PDJN(R/L).1025.11	5	10	25	ISO - DN . . 11 04 . . ANSI - DN . . 33 . .	0.06	WDE.ER2.101.003	WDE.ER4.101.017	WDE.ER3.101.000	WDE.ER1.101.000	LWX.ER1.007.002

PDNN N 62.5°/55°

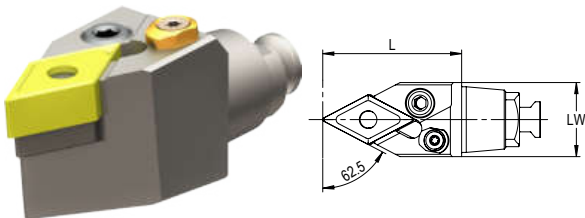

Bestell.Nr. / Order number/ Code	LW	f	L	Wendeplatte/ Insert/ Plaquette	kg					
LW4.PDNNN.0030.11	4	0	30	ISO - DN . . 11 04 . . ANSI - DN . . 33 . .	0.05	WDE.ER2.101.003	WDE.ER4.101.017	WDE.ER3.101.000	WDE.ER1.101.000	LWX.ER1.007.002
LW5.PDNNN.0030.11	5	0	30	ISO - DN . . 11 04 . . ANSI - DN . . 33 . .	0.07	WDE.ER2.101.003	WDE.ER4.101.017	WDE.ER3.101.000	WDE.ER1.101.000	LWX.ER1.007.002

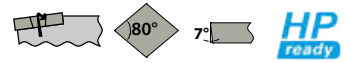
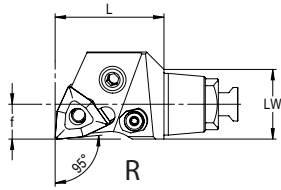

Bestell.Nr. / Order number/ Code	LW	f	L	Wendeplatte/ Insert/ Plaque	kg					
LW4.PWLN(R/L).0825.06	4	8	25	ISO - WN . . 06 04 . . ANSI - WN . . 33 . .	0.04	WWE.ER2.102.003	WDE.ER4.101.017	WDE.ER3.101.000	WDE.ER1.101.000	LWX.ER1.007.002
LW5.PWLN(R/L).1025.06	5	10	25	ISO - WN . . 06 04 . . ANSI - WN . . 33 . .	0.07	WWE.ER2.102.003	WDE.ER4.101.017	WDE.ER3.101.000	WDE.ER1.101.000	LWX.ER1.007.002

SVVC N 72.5°/35°

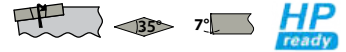
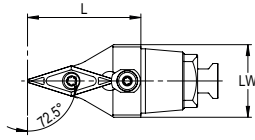

Bestell.Nr. / Order number/ Code	LW	f	L	Wendeplatte/ Insert/ Plaquette	kg				
LW2.SVVCN.0025.11	2	0	25	ISO - VC .. 11 03 .. ANSI - VC .. 22 ..	0.02	WCA.ER1.001.000	WCA.ER2.001.006 (0.9 Nm)	LWX.ER1.007.002	LW2.U00.ER1.000
LW3.SVVCN.0025.11	3	0	25	ISO - VC .. 11 03 .. ANSI - VC .. 22 ..	0.03	WCA.ER1.001.000	WCA.ER2.001.006 (0.9 Nm)	LWX.ER1.007.002	LW3.U00.ER1.000
LW3.SVVCN.0030.13	3	0	30	ISO - VC .. 13 03 .. ANSI - VC .. 252 ..	0.03	WCA.ER1.001.000	WCA.ER2.001.007 (0.9 Nm)	LWX.ER1.007.002	LW3.U00.ER1.000
LW4.SVVCN.0025.11	4	0	25	ISO - VC .. 11 03 .. ANSI - VC .. 22 ..	0.04	WCA.ER1.001.000	WCA.ER2.001.006 (0.9 Nm)	LWX.ER1.007.002	LW4.U00.ER1.000
LW4.SVVCN.0030.13	4	0	30	ISO - VC .. 13 03 .. ANSI - VC .. 252 ..	0.05	WCA.ER1.001.000	WCA.ER2.001.007 (0.9 Nm)	LWX.ER1.007.002	LW4.U00.ER1.000
LW4.SVVCN.0035.16	4	0	35	ISO - VC .. 16 04 .. ANSI - VC .. 33 ..	0.06	WCB.ER1.001.000	WCB.ER2.001.009 (3.0 Nm)	LWX.ER1.007.002	LW4.U00.ER1.000
LW5.SVVCN.0035.16	5	0	35	ISO - VC .. 16 04 .. ANSI - VC .. 33 ..	0.07	WCB.ER1.001.000	WCB.ER2.001.009 (3.0 Nm)	LWX.ER1.007.002	LW4.U00.ER1.000



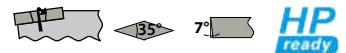
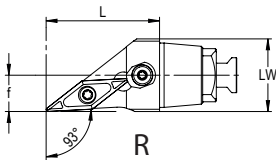

SVJC R/L 93°/35°

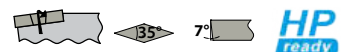
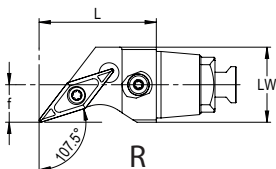

Bestell.Nr. / Order number/ Code	LW	f	L	Wendeplatte/ Insert/ Plaquette	kg				
LW2.SVJC(R/L).0525.11	2	5	25	ISO - VC .. 11 03 .. ANSI - VC .. 22 ..	0.03	WCA.ER1.001.000	WCA.ER2.001.006 (0.9 Nm)	LWX.ER1.007.002	LW2.U00.ER1.000
LW3.SVJC(R/L).0625.11	3	6	25	ISO - VC .. 11 03 .. ANSI - VC .. 22 ..	0.03	WCA.ER1.001.000	WCA.ER2.001.006 (0.9 Nm)	LWX.ER1.007.002	LW3.U00.ER1.000
LW3.SVJC(R/L).0630.13	3	6	30	ISO - VC .. 13 03 .. ANSI - VC .. 252 ..	0.03	WCA.ER1.001.000	WCA.ER2.001.007 (0.9 Nm)	LWX.ER1.007.002	LW3.U00.ER1.000
LW4.SVJC(R/L).0825.11	4	8	25	ISO - VC .. 11 03 .. ANSI - VC .. 22 ..	0.04	WCA.ER1.001.000	WCA.ER2.001.006 (0.9 Nm)	LWX.ER1.007.002	LW4.U00.ER1.000
LW4.SVJC(R/L).0830.13	4	8	30	ISO - VC .. 13 03 .. ANSI - VC .. 252 ..	0.05	WCA.ER1.001.000	WCA.ER2.001.007 (0.9 Nm)	LWX.ER1.007.002	LW4.U00.ER1.000
LW4.SVJC(R/L).0835.16	4	8	35	ISO - VC .. 16 04 .. ANSI - VC .. 33 ..	0.06	WCB.ER1.001.000	WCB.ER2.001.009 (3.0 Nm)	LWX.ER1.007.002	LW4.U00.ER1.000
LW5.SVJC(R/L).1035.16	5	10	35	ISO - VC .. 16 04 .. ANSI - VC .. 33 ..	0.07	WCB.ER1.001.000	WCB.ER2.001.009 (3.0 Nm)	LWX.ER1.007.002	LW4.U00.ER1.000

SVHC R/L 107.5°/35°



Bestell.Nr. / Order number/ Code	LW	f	L	Wendeplatte/ Insert/ Plaquette	kg				
LW2.SVHC(R/L).0525.11	2	5	25	ISO - VC .. 11 03 .. ANSI - VC .. 22 ..	0.03	WCA.ER1.001.000	WCA.ER2.001.006 (0.9 Nm)	LWX.ER1.007.002	LW2.U00.ER1.000
LW3.SVHC(R/L).0625.11	3	6	25	ISO - VC .. 11 03 .. ANSI - VC .. 22 ..	0.03	WCA.ER1.001.000	WCA.ER2.001.006 (0.9 Nm)	LWX.ER1.007.002	LW3.U00.ER1.000
LW4.SVHC(R/L).0825.11	4	8	25	ISO - VC .. 11 03 .. ANSI - VC .. 22 ..	0.04	WCA.ER1.001.000	WCA.ER2.001.006 (0.9 Nm)	LWX.ER1.007.002	LW4.U00.ER1.000
LW5.SVHC(R/L).1035.16	5	10	35	ISO - VC .. 16 04 .. ANSI - VC .. 33 ..	0.08	WCB.ER1.001.000	WCB.ER2.001.009 (3.0 Nm)	LWX.ER1.007.002	LW4.U00.ER1.000

SVVB N 72.5°/35°

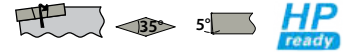
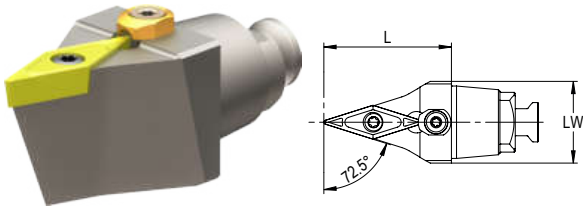

Bestell.Nr. / Order number/ Code	LW	f	L	Wendeplatte/ Insert/ Plaquette	kg				
LW2.SVVB.N.0025.11	2	0	25	ISO - VB .. 11 03 .. ANSI - VB .. 22 ..	0.02	WCA.ER1.001.000	WCA.ER2.001.006 (0.9 Nm)	LWX.ER1.007.002	LW2.U00.ER1.000
LW3.SVVB.N.0025.11	3	0	25	ISO - VB .. 11 03 .. ANSI - VB .. 22 ..	0.03	WCA.ER1.001.000	WCA.ER2.001.006 (0.9 Nm)	LWX.ER1.007.002	LW3.U00.ER1.000
LW4.SVVB.N.0025.11	4	0	25	ISO - VB .. 11 03 .. ANSI - VB .. 22 ..	0.04	WCA.ER1.001.000	WCA.ER2.001.006 (0.9 Nm)	LWX.ER1.007.002	LW4.U00.ER1.000
LW5.SVVB.N.0025.11	5	0	25	ISO - VB .. 11 03 .. ANSI - VB .. 22 ..	0.05	WCA.ER1.001.000	WCA.ER2.001.006 (0.9 Nm)	LWX.ER1.007.002	LW4.U00.ER1.000

SVJB R/L 93°/35°

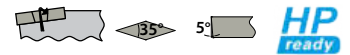
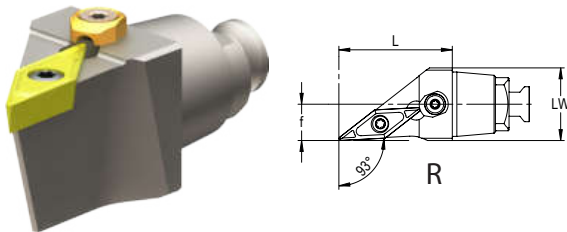

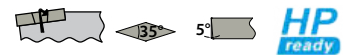
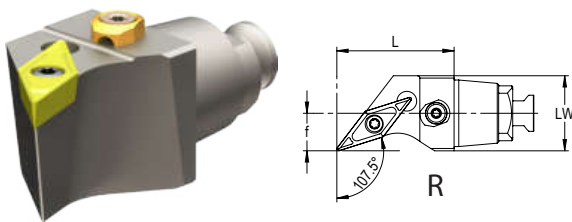

Bestell.Nr. / Order number/ Code	LW	f	L	Wendeplatte/ Insert/ Plaquette	kg				
LW2.SVJB(R/L).0525.11	2	5	25	ISO - VB .. 11 03 .. ANSI - VB .. 22 ..	0.03	WCA.ER1.001.000	WCA.ER2.001.006 (0.9 Nm)	LWX.ER1.007.002	LW2.U00.ER1.000
LW3.SVJB(R/L).0625.11	3	6	25	ISO - VB .. 11 03 .. ANSI - VB .. 22 ..	0.03	WCA.ER1.001.000	WCA.ER2.001.006 (0.9 Nm)	LWX.ER1.007.002	LW3.U00.ER1.000
LW4.SVJB(R/L).0825.11	4	8	25	ISO - VB .. 11 03 .. ANSI - VB .. 22 ..	0.04	WCA.ER1.001.000	WCA.ER2.001.006 (0.9 Nm)	LWX.ER1.007.002	LW4.U00.ER1.000
LW5.SVJB(R/L).1025.11	5	10	25	ISO - VB .. 11 03 .. ANSI - VB .. 22 ..	0.05	WCA.ER1.001.000	WCA.ER2.001.006 (0.9 Nm)	LWX.ER1.007.002	LW4.U00.ER1.000

SVHB R/L 107.5°/35°



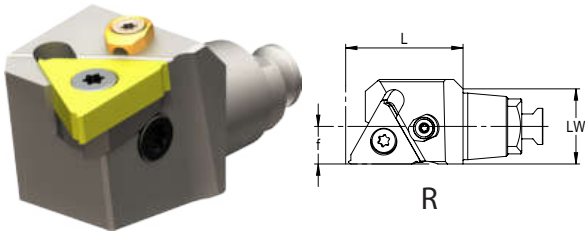



Bestell.Nr. / Order number/ Code	LW	f	L	Wendeplatte/ Insert/ Plaquette	kg				
LW2.SVHB(R/L).0520.11	2	5	25	ISO - VB .. 11 03 .. ANSI - VB .. 22 ..	0.03	WCA.ER1.001.000	WCA.ER2.001.006 (0.9 Nm)	LWX.ER1.007.002	LW2.U00.ER1.000
LW3.SVHB(R/L).0625.11	3	6	25	ISO - VB .. 11 03 .. ANSI - VB .. 22 ..	0.03	WCA.ER1.001.000	WCA.ER2.001.006 (0.9 Nm)	LWX.ER1.007.002	LW3.U00.ER1.000
LW4.SVHB(R/L).0825.11	4	8	25	ISO - VB .. 11 03 .. ANSI - VB .. 22 ..	0.04	WCA.ER1.001.000	WCA.ER2.001.006 (0.9 Nm)	LWX.ER1.007.002	LW4.U00.ER1.000
LW5.SVHB(R/L).1025.11	5	10	25	ISO - VB .. 11 03 .. ANSI - VB .. 22 ..	0.06	WCA.ER1.001.000	WCA.ER2.001.006 (0.9 Nm)	LWX.ER1.007.002	LW4.U00.ER1.000

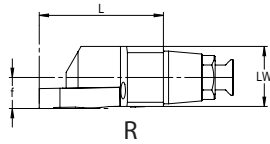

Bestell.Nr. / Order number/ Code	LW	f	L	Wendeplatte/ Insert/ Plaquette	kg					
LW3.SER.0625.16	3	6	25	16 ER	0.04	WGB.ER1.001.000	WGB.ER2.001.012 (2.0 Nm)	WGB.ER2.102.003	WGB.ER3.001.007 (2.0 Nm)	LWX.ER1.007.002
LW3.SEL.0625.16	3	6	25	16 EL	0.04	WGB.ER1.001.000	WGB.ER2.001.012 (2.0 Nm)	WGB.ER2.101.003	WGB.ER3.001.007 (2.0 Nm)	LWX.ER1.007.002
LW4.SER.0825.16	4	8	25	16 ER	0.06	WGB.ER1.001.000	WGB.ER2.001.012 (2.0 Nm)	WGB.ER2.102.003	WGB.ER3.001.007 (2.0 Nm)	LWX.ER1.007.002
LW4.SEL.0825.16	4	8	25	16 EL	0.06	WGB.ER1.001.000	WGB.ER2.001.012 (2.0 Nm)	WGB.ER2.101.003	WGB.ER3.001.007 (2.0 Nm)	LWX.ER1.007.002
LW5.SER.1025.16	5	10	25	16 ER	0.08	WGB.ER1.001.000	WGB.ER2.001.012 (2.0 Nm)	WGB.ER2.102.003	WGB.ER3.001.007 (2.0 Nm)	LWX.ER1.007.002
LW5.SEL.1025.16	5	10	25	16 EL	0.08	WGB.ER1.001.000	WGB.ER2.001.012 (2.0 Nm)	WGB.ER2.101.003	WGB.ER3.001.007 (2.0 Nm)	LWX.ER1.007.002



compatible with **Applitec Top-Line 730/740**



Bestell.Nr. / Order number/ Code	LW	f	L	Wendeplatte/ Insert/ Plaquette	kg			
LW3-730-12-0632-JET L	3	6	32	73_	0.03	C-T8	V-M3X7-T8 (3.0 Nm)	LW3.U00.ER1.000
LW3-740-12-0632-JET R	3	6	32	74_	0.03	C-T8	V-M3X7-T8 (3.0 Nm)	LW3.U00.ER1.000
LW4-730-16-0832-JET L	4	8	32	73_	0.04	C-T8	V-M3X7-T8 (3.0 Nm)	LW4.U00.ER1.000
LW4-740-16-0832-JET R	4	8	32	74_	0.04	C-T8	V-M3X7-T8 (3.0 Nm)	LW4.U00.ER1.000

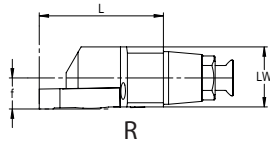

compatible with **Applitec Top-Line 750/760**

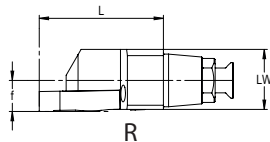

Bestell.Nr. / Order number/ Code	LW	f	L	Wendeplatte/ Insert/ Plaquette	kg			
LW3-750-12-0643-JET L	3	6	43	75_	0.03	C-T15	V-M4X9-T15 (3.0 Nm)	LW3.U00.ER1.000
LW3-760-12-0643-JET R	3	6	43	76_	0.03	C-T8	V-M4X9-T15 (3.0 Nm)	LW3.U00.ER1.000
LW4-750-16-0843-JET L	4	8	43	75_	0.04	C-T8	V-M4X9-T15 (3.0 Nm)	LW4.U00.ER1.000
LW4-760-16-0843-JET R	4	8	43	76_	0.04	C-T8	V-M4X9-T15 (3.0 Nm)	LW4.U00.ER1.000

compatible with **Applitec Top-Line 770/780**



Bestell.Nr. / Order number/ Code	LW	f	L	Wendeplatte/ Insert/ Plaquette	kg			
LW4-770-16-0856-JET L	4	8	56	77_	0.04	C-T8	V-M4X9-T15 (3.0 Nm)	LW4.U00.ER1.000
LW4-780-16-0856-JET R	4	8	56	78_	0.04	C-T8	V-M4X9-T15 (3.0 Nm)	LW4.U00.ER1.000

compatible with **Simtek TH2**

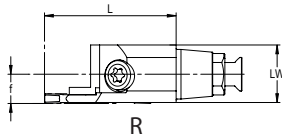

Bestell.Nr. / Order number/ Code	LW	f	L	Wendeplatte/ Insert/ Plaquette Connect code	kg			
TOS.K.TH2.15.02A L	3	6	27	TH2.15	0.03	WCB.ER1.001.000	TH2 M4X16,6 T15F (1.5 Nm)	LW3.U00.ER1.000
TOS.K.TH2.15.02A R	3	6	27	TH2.15	0.03	WCB.ER1.001.000	TH2 M4X16,6 T15F (1.5 Nm)	LW3.U00.ER1.000
TOS.K.TH2.20.02A L	3	6	27	TH2.20	0.03	WCB.ER1.001.000	TH2 M4X16,6 T15F (2.0 Nm)	LW3.U00.ER1.000
TOS.K.TH2.20.02A R	3	6	27	TH2.20	0.03	WCB.ER1.001.000	TH2 M4X16,6 T15F (2.0 Nm)	LW3.U00.ER1.000
TOS.K.TH2.25.02A L	3	6	27	TH2.25	0.03	WCB.ER1.001.000	TH2 M4X16,6 T15F (2.5 Nm)	LW3.U00.ER1.000
TOS.K.TH2.25.02A R	3	6	27	TH2.25	0.03	WCB.ER1.001.000	TH2 M4X16,6 T15F (2.5 Nm)	LW3.U00.ER1.000
TOS.K.TH2.30.02A L	3	6	27	TH2.30	0.03	WCB.ER1.001.000	TH2 M4X16,6 T15F (3.0 Nm)	LW3.U00.ER1.000
TOS.K.TH2.30.02A R	3	6	27	TH2.30	0.03	WCB.ER1.001.000	TH2 M4X16,6 T15F (3.0 Nm)	LW3.U00.ER1.000

compatible with **Simtek TK2.G**

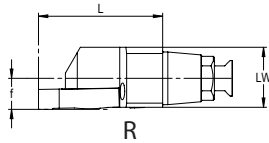

Bestell.Nr. / Order number/ Code	LW	f	L	Wendeplatte/ Insert/ Plaquette Connect code	kg			
TOS.K.TK2.G.02A.IC L	3	6	24	TK2.G.L.04	0.03	J00.895.002.010	M M3,5X11 T10F (3.0 Nm)	LW3.U00.ER1.000
TOS.K.TK2.G.02A.IC R	3	6	24	TK2.G.R.04	0.03	J00.895.002.010	M M3,5X11 T10F (3.0 Nm)	LW3.U00.ER1.000

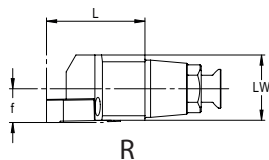

compatible with **Simtek TK2.A**

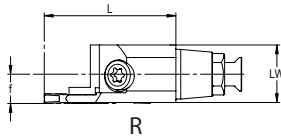
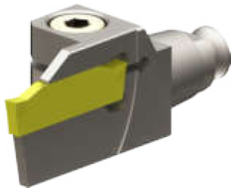

Bestell.Nr. / Order number/ Code	LW	f	L	Wendeplatte/ Insert/ Plaquette Connect code	kg			
TOS.K.TK2.A.02A.IC L	3	6	17.5	TK2.A.L.04	0.02	J00.895.002.010	M M3,5X11 T10F (3.0 Nm)	LW3.U00.ER1.000
TOS.K.TK2.A.02A.IC R	3	6	17.5	TK2.A.R.04	0.02	J00.895.002.010	M M3,5X11 T10F (3.0 Nm)	LW3.U00.ER1.000

compatible with **Achteck AC**



Bestell.Nr. / Order number/ Code	LW	f	L	Wendeplatte/ Insert/ Plaque	kg		
LW3.TFx.RA1.028	3	6	28	AC.. 20..	0.02	DIN 7984 - M4 x 12 (5.0 Nm)	LW3.U00.ER1.000



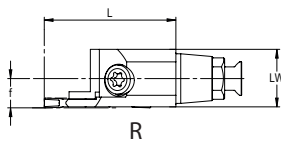

compatible with **Whizcut K-type**

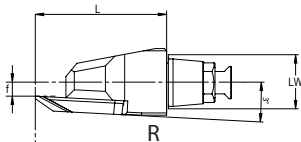
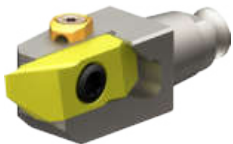

Bestell.Nr. / Order number/ Code	LW	f	L	Wendeplatte/ Insert/ Plaque	kg	
LW3.KFW.R01.022	3	6	22	K15ER	0.02	LW3.U00.ER1.000



compatible with **Mitsubishi BTAT**



Bestell.Nr. / Order number/ Code	LW	f	L	Wendeplatte/ Insert/ Plaque	kg				
LV3.KFM.R01.018	3	2.5	23	BTAT	0.02	WCB.ER1.001.000	WCB.ER2.001.009 (3.0 Nm)	LWX.ER1.007.002	LW3.U00.ER1.000

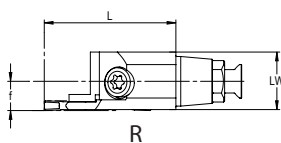



compatible with **Korloy KGT**

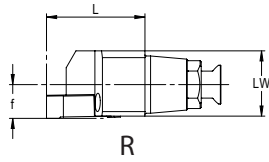

Bestell.Nr. / Order number/ Code	LW	f	L	Wendeplatte/ Insert/ Plaque	kg		
LV3.KFK.R02.022	3	6	32	KGT	0.02	M5x14 DIN 7984 (5.0 Nm)	LW3.U00.ER1.000



compatible with **Tungaloy JXB**

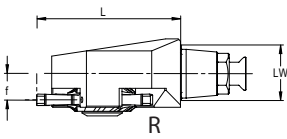

Bestell.Nr. / Order number/ Code	LW	f	L	Wendeplatte/ Insert/ Plaquette	kg				
LW3.KFT.R01.022	3	6	28	JXB..	0.02	WCB.ER1.001.000	WCB.ER2.001.009 (3.0 Nm)	LWX.ER1.007.002	LW3.U00.ER1.000

compatible with **Tungaloy TC 27**







Bestell.Nr. / Order number/ Code	LW	f	L	Wendeplatte/ Insert/ Plaquette	kg			
LW3.KFT.R27.025	3	6	25	TC.. 27..	0.03	WCC.ER1.001.000	WCC.ER2.001.010 (5.0 Nm)	LW3.U00.ER1.000

Grundhalter rund

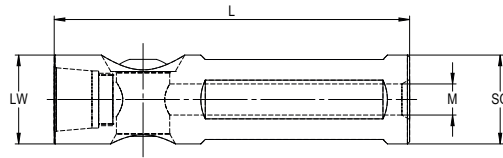
Round holders

Porte-outil rond



Bestell.Nr. / Order number/ Code	LW	SG	L	Coolant M	kg				
U16.LW3.K01.080	3	16	80	M8x1	0.09	LW3.ER1.012.014 (3.8 Nm)	LWX.ER1.008.004	J00.895.000.038	J00.895.002.015 (TX15)
U20.LW4.K01.080	4	20	80	M8x1	0.15	LW4.ER1.014.018 (5.7 Nm)	LWX.ER1.008.004	J00.895.000.057	J00.895.002.020 (TX20)
U19.LW5.K01.080	5	19.05	80	M8x1	0.14	LW4.ER1.014.018 (5.7 Nm)	LWX.ER1.008.004	J00.895.000.057	J00.895.002.020 (TX20)
U20.LW5.K01.080	5	20	80	M8x1	0.15	LW4.ER1.014.018 (5.7 Nm)	LWX.ER1.008.004	J00.895.000.057	J00.895.002.020 (TX20)
U22.LW5.K01.080	5	22	80	M8x1	0.19	LW4.ER1.014.019 (5.7 Nm)	LWX.ER1.008.004	J00.895.000.057	J00.895.002.020 (TX20)
U25.LW5.K01.080	5	25	80	M8x1	0.26	LW4.ER1.015.023 (5.7 Nm)	LWX.ER1.008.004	J00.895.000.057	J00.895.002.020 (TX20)
U26.LW5.K01.080	5	25.4	80	M8x1	0.27	LW4.ER1.015.023 (5.7 Nm)	LWX.ER1.008.004	J00.895.000.057	J00.895.002.020 (TX20)

- für effiziente Drehbearbeitung
- mit Kühlmitteldirektanschluss
- Sonderabmasse auf Anfrage
- Benutzung eines Drehmomentschlüssel empfohlen

- to turn efficiently
- with direct coolant connection
- Special dimensions on request
- Recommended use of dynamometric key



- pour un tournage efficace
- avec raccord direct de liquide de refroidissement
- Dimensions spéciales sur demande
- Utilisation clé dynamométrique recommandée

Spannzangenfutter

Collet Chuck

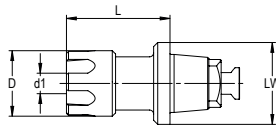
Porte-pinces





Bestell.Nr. / Order number/ Code	LW	D	L	Spannzange	d1	kg		
LW3.E11.K01.026	3	16	26	ER11	0.5 . 7	0.03	LW3.U00.ER1.000	E11.ER1.001.012
LW5.E11.K01.026	5	16	26	ER11	0.5 . 7	0.05	LW4.U00.ER1.000	E11.ER1.001.012
LW5.E16.K01.035	5	22	35	ER16	0.5 . 10	0.07	LW4.U00.ER1.000	E16.ER1.001.018

Halter für Schneideinsätze

Boring bar holder

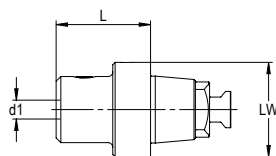
Porte-outils d'alésage



Bestell.Nr. / Order number/ Code	LW	L1	d1	kg			
LW5.D04.K01.020	5	20	4	0.05	LW4.U00.ER1.000	A25.BG4.007.020	ISO 4026 . M4 x 5
LW5.D07.K01.025	5	25	7	0.06	LW4.U00.ER1.000	A25.BG4.007.020	ISO 4026 . M4 x 5

Schneideinsätze

Boring bars

Barres d'alésage

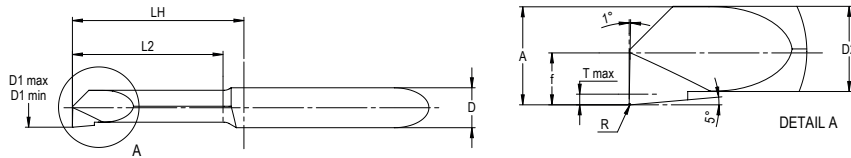

Bestell.Nr. / Order number/ Code	D	L2	D min	D max	R	A	D2	f	LH	T max
255.004.003.013	4.0	1.2	0.3	0.7	-	0.25	0.15	0.15	11.0	0.03
255.004.006.013	4.0	2.5	0.6	1.1	-	0.55	0.46	0.30	11.0	0.05
255.004.010.013	4.0	4.0	1.0	2.3	0.05	0.95	0.65	0.50	11.0	0.1
255.004.022.013	4.0	6.0	2.2	3.3	0.05	2.00	1.55	1.10	11.0	0.2
255.004.032.013	4.0	10.2	3.2	4.3	0.05	3.00	2.55	1.60	11.0	0.2
255.004.039.018	4.0	15.2	3.9	(7.1)	0.05	3.70	3.45	1.95	16.0	0.3
255.007.052.023	7.0	20.3	5.2	6.3	0.05	5.00	4.25	2.60	21.0	0.5
255.007.062.023	7.0	20.3	6.2	7.3	0.05	6.00	5.25	3.10	21.0	0.5
255.007.069.028	7.0	25.4	6.9	12.1	0.20	6.70	6.25	3.45	26.0	0.5

Schneidplatten

Inserts

Plaquettes

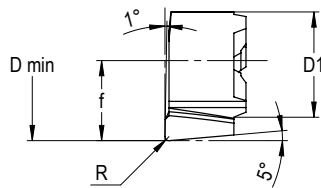
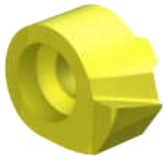

Bestell.Nr. / Order number/ Code	D min	Dd max	R	f	D1	Tmax	Code
283.007.069.004	6.9	8.1	0.2	3.45	4.8	1.0	D07
283.007.079.004	7.9	9.1	0.2	3.95	4.8	1.0	D07
283.007.089.004	8.9	10.1	0.2	4.45	4.8	1.0	D07
283.010.099.004	9.9	12.1	0.2	4.95	7	1.0	D10
283.010.119.004	11.9	14.1	0.2	5.95	7	1.0	D10
283.010.139.004	13.9	19.1	0.2	6.95	7	1.0	D10

Adapter für Schneidplatten

Adapter for inserts

Adapter pour les plaquettes

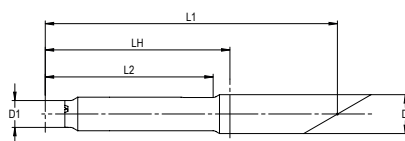

Bestell.Nr. / Order number/ Code	ØD h6	L2	Ø d1	L1	LH	Schraube/ screw	Torx	Code
282.007.007.033	7.0	30	4.8	56	31	M2x7.5 (900.254.020.007)	T7	D07
282.007.010.038	7.0	35	7.0	61	36	M3x9.0 (900.254.030.009)	T9	D10

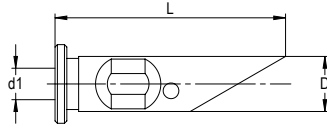

Code/ Bestell-Nr. / Order number	D	d1	L
224.007.004.030	7	4	(30)
224.007.006.030	7	6	(30)

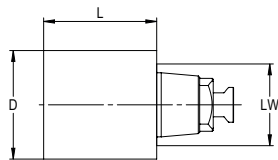

Bestell.Nr. / Order number / Code	LW	D	L	kg	
LW2.Ro1.015.030	2	15	30	0.04	LW2.U00.ER1.000
LW3.Ro1.023.037	3	23	37	0.13	LW3.U00.ER1.000
LW4.Ro1.035.030	4	35	30	0.25	LW4.U00.ER1.000
LW4.Ro1.030.043	4	30	43	0.25	LW4.U00.ER1.000
LW5.Ro1.035.030	5	30	30	0.25	LW4.U00.ER1.000
LW5.Ro1.030.043	5	30	43	0.25	LW4.U00.ER1.000

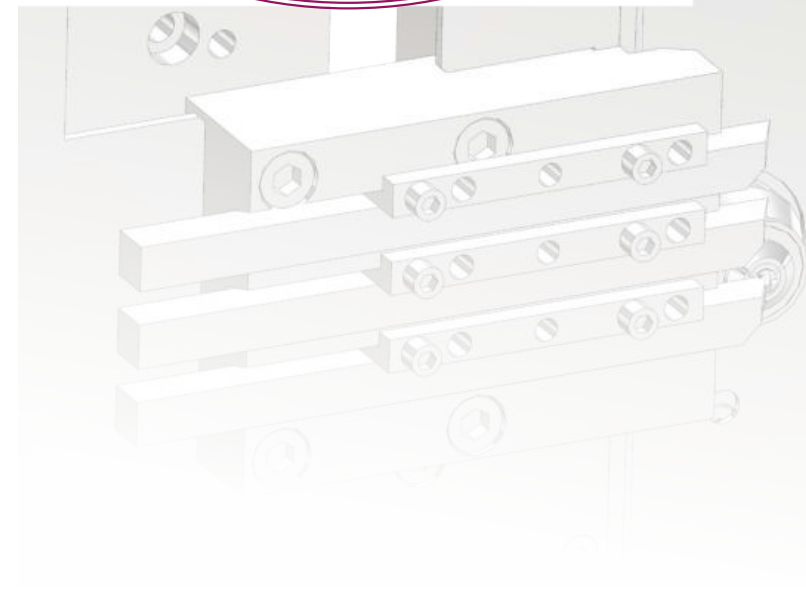
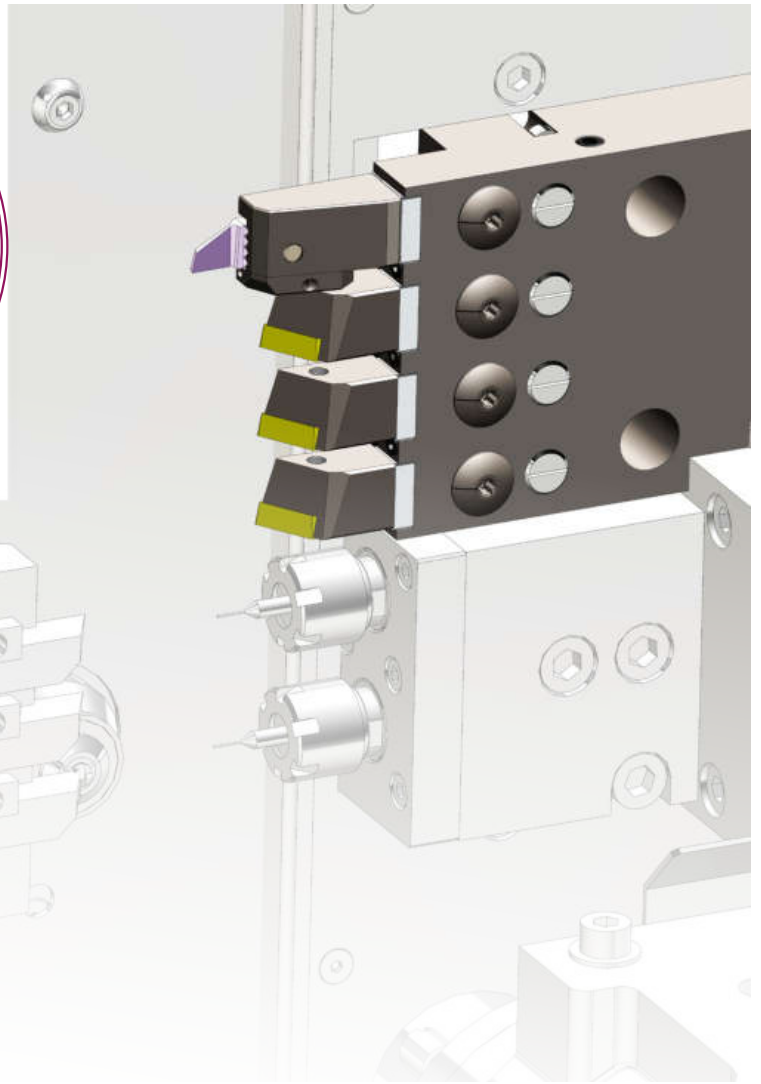
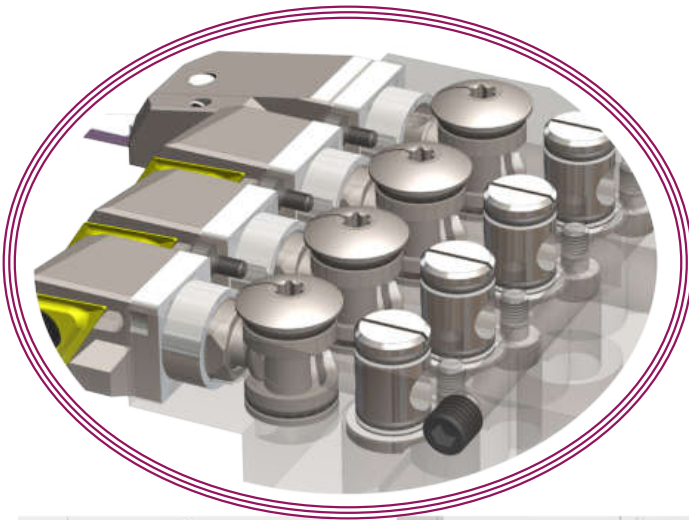

- für effiziente Drehbearbeitung
- mit Kühlmitteldirektanschluss
- Einfach einzurichten, schnell & genau wechseln
- Hohe Prozessfähigkeit
- Weniger Spanfang

- to turn efficiently
- with direct coolant connection
- Easy to set up, switch quickly & accurately
- High process capability
- Less problems with chips

- pour un tournage efficace
- avec raccord direct de liquide de refroidissement
- Facile à configurer, basculez rapidement et avec précision
- Capacité de traitement élevée
- Moins de problèmes avec les puces

SWISS-MICRO QUICK-CHANGE SYSTEM

- Manipulation facile
- Changement d'outil rapide
- Pré-reglage précis
- Interface rigide

Système innovant de changement rapide ST-Micro - pour les outils statiques

Développé pour les décolleteuses et les tours automatiques multi-broches. La réduction du temps non productif a été le principal objectif du processus de développement de cet outil. Le changement des plaquettes n'est souvent possible que sous condition, en raison de la conception des machines. Dans la plupart des cas, les supports de base complets doivent être retirés. Cela prend beaucoup de temps et entraîne des temps d'arrêt importants. C'est désormais une chose du passé. Le système ST-Micro offre des solutions pour l'usinage interne et externe. La gamme comprend des supports carrés de dimensions 12x12 et 16x16 ainsi que des supports ronds de Ø20, 22 et 25 mm et des dimensions en pouces de 19,05 et 25,4 mm. La précision, la stabilité et la facilité de maniabilité ne laissent rien à désirer.

- Les supports de base avec raccordement pour l'arrosage permettent une utilisation dans n'importe quelle position possible dans la machine.
- L'utilisation simple d'une seule main permet un changement sûr et facile des adaptateurs de plaquettes.
- Tous les adaptateurs peuvent être pré-réglés et mesurés en dehors de la machine.
- Le changement d'outil s'effectue en quelques secondes.
- Les temps de préparation et de non-productivité sont réduits au minimum et la productivité de votre machine est augmentée au maximum.
- La conception de l'interface garantit un positionnement exactpositionnement exact dans la plage des μ .

SWISS-MICRO QUICK-CHANGE SYSTEM

- Einfaches Handling
 - Schnelle Werkzeugwechsel
 - Präzise Voreinstellung
 - Stabile Schnittstelle
- Easy handling
 - Fast tool change
 - Precise presetting
 - Stable interface

Innovatives Schnellwechselsystem ST-Micro – für statische Werkzeuge

Entwickelt für Langdrehmaschinen und Mehrspindeldrehautomaten.

Reduktion von Nebenzeiten stand bei Entwicklungsprozess von diesem Werkzeug im Vordergrund. Der Wechsel der Wendeschneidplatten ist oft durch die Bauweise der Maschinen nur bedingt möglich. Meist müssen die kompletten Grundhalter ausgebaut werden. Dies ist sehr zeitaufwändig und führt zu hohen Stillstandszeiten. Das gehört jetzt der Vergangenheit an.

Das ST-Micro System, bietet Lösungen für die Innen- und Außenbearbeitung. Das Sortiment umfasst Vierkantaufnahmen der Baugrößen 12x12 / 16x16 / 20x20 / 1/2"x1/2" / 5/8"x 5/8" sowie Rundaufnahmen Ø20, 22 und 25mm sowie die Inch Dimensionen 19.05 und 25.4 mm. Präzision, Stabilität und Bedienerfreundlichkeit lassen keine Wünsche offen.

- Grundhalter mit integriertem Kühlmittelanschluss ermöglichen den Einsatz auf jeder möglichen Position in der Maschine.
- Die einfache Einhandbedienung erlaubt einen sicheren und einfachen Wechsel der Wendeschneidplattenadapter.
- Sämtliche Adapter können außerhalb der Maschine voreingestellt und vermessen werden.
- Der Werkzeugwechsel erfolgt innerhalb weniger Sekunden.
- Die Rüst- und Nebenzeiten werden auf ein Minimum reduziert und die Produktivität Ihrer Maschine auf ein Maximum gesteigert.
- Die Konzeption der Schnittstelle garantiert eine exakte Lagepositionierung und Genauigkeit im einstelligen µ-Bereich.

Innovative quick-change system ST-Micro - for static tools

Designed for Swiss-type machines and multi-spindle lathes.

Reduce the non-productive time was the highest priority by the developing process of this tool. To change the indexable inserts is often limited by the design of the machines. In most cases, the complete basic holder must be removed. This is very time consuming and leads to high downtime. This is now a thing of the past.

The ST-Micro system offers solutions for internal and external machining. The assortment includes square holders of the sizes 12x12 / 16x16 / 20x20 / 1/2"x1/2" / 5/8"x 5/8" as well as round shanks Ø20, 22 and 25mm as well as the inch dimensions 19.05 and 25.4 mm. Precision, stability and user-friendliness is guaranteed.

- Basic holder with integrated coolant connection can be used at every possible position in the machine.
- The simple one-hand operation allows a safe and secure easy change of indexable insert adapter.
- All adapters can be adjusted and preset outside the machine.
- The tool change takes place within a few seconds.
- Setup times are kept to a minimum - productivity of your machine to a maximum
- The design of the interface guarantees an exact location positioning and accuracy in the single-digit µ range.

SWISS+TOOLS[®]
SCHAUBLIN

Swiss Tool Systems AG
Wydenstrasse 28
CH-8575 Bürglen
Phone +41 (0)71 634 85 20
Fax +41 (0)71 634 85 29
www.swisstools.org